

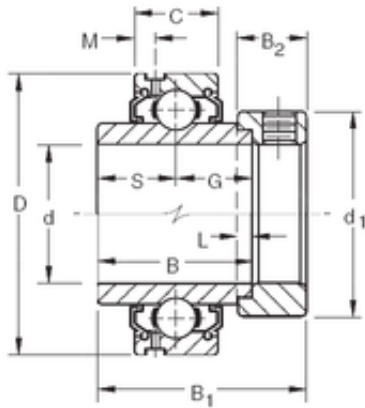

NTN BEARING USA CORP.

25,4 mm x 52 mm x 34,92 mm TIMKEN G1100KLL Insert Bearings Cylindrical OD



Bearing No. G1100KLL

Size	25.4x52x34.92 mm
Bore Diameter	25,4 mm
Outer Diameter	52 mm
Width	34,92 mm
d	25,4 mm
D	52 mm
B	34,92 mm
C	15 mm
d1	38,1 mm
B1	44,45 mm
B2	13,5 mm
G	17,5 mm
L	4 mm
M	3,86 mm
S	17,5 mm
Weight	0,222 Kg
Basic dynamic load rating (C)	15,8 kN

G1100KLL Bearing 2D drawings and 3D CAD models